

HOMEDICS®

Professional HEPA Air Cleaner



Instruction Manual

AR-20-GB

3 year
guarantee



**READ ALL INSTRUCTIONS BEFORE USE.
SAVE THESE INSTRUCTIONS FOR FUTURE REFERENCE.**

IMPORTANT SAFEGUARDS:

WHEN USING ELECTRICAL PRODUCTS, ESPECIALLY WHEN CHILDREN ARE PRESENT, BASIC SAFETY PRECAUTIONS SHOULD ALWAYS BE FOLLOWED, INCLUDING THE FOLLOWING:

- ALWAYS unplug the appliance from the electrical outlet immediately after using and before cleaning. To disconnect, turn all controls to the 'OFF' position, then remove plug from outlet.
- NEVER leave an appliance unattended when plugged in. Unplug from the mains outlet when not in use and before putting on or taking off parts or attachments.
- This appliance is not intended for use by persons (including children) with reduced physical, sensory or mental capabilities, or lack of experience and knowledge, unless they have been given supervision or instruction concerning use of the appliance by a person responsible for their safety. Children should be supervised to ensure that they do not play with the appliance.
- DO NOT reach for an appliance that has fallen in water or other liquids. Switch off at the mains and unplug it immediately. Keep dry – DO NOT operate in wet or moist conditions.
- NEVER insert pins or other metallic fasteners into the appliance.
- Use this appliance for the intended use as described in this booklet. DO NOT use attachments not recommended by HoMedics.
- NEVER operate the appliance if it has a damaged cord or plug, if it is not working properly, if it has been dropped or damaged, or dropped into water. Return it to the HoMedics Service Centre for examination and repair.
- Keep cord away from heated surfaces.
- Excessive use could lead to the product's excessive heating and shorter life. Should this occur, discontinue use and allow the unit to cool before operating.
- NEVER drop or insert any object into any opening.
- DO NOT operate where aerosol (spray) products are being used or where oxygen is being administered.
- DO NOT operate under a blanket or pillow. Excessive heating can occur and cause fire, electrocution or injury to persons.
- DO NOT carry this appliance by the cord or use cord as a handle.
- DO NOT use outdoors.
- DO NOT crush. Avoid sharp folds.
- This product requires a 220-240 V AC power.
- DO NOT attempt to repair the appliance. There are no user serviceable parts. For service, send to a HoMedics Service Centre. All servicing of this appliance must be performed by authorised HoMedics service personnel only.
- Never block the air openings of the appliance or place it on a soft surface, such as a bed or couch. Keep air openings free of lint, hair etc.
- Do not place or store appliance where it can fall or be pulled into a bath or sink. Do not place in or drop into water or other liquid.
- Failure to follow the above may result in the risk of fire or injury.
- Burns can result from improper use.

SAFETY CAUTIONS :

PLEASE READ THIS SECTION CAREFULLY BEFORE USING THE APPLIANCE.

- Always place the air cleaner on a firm, level surface.
- Always place the air cleaner at least 16cm away from walls and 1 metre from heat sources such as stoves, radiators, or heaters.
- DO NOT use while bathing or in the shower.
- Keep dry - DO NOT operate in a wet or moist condition.
- This appliance is designed for personal, non-professional use only.
- Extreme caution is necessary when any air cleaner is used by or near children or invalids and whenever the air cleaner is left operating and unattended.
- Always unplug the air cleaner when not in use.
- Do not operate the air cleaner with a damaged cord or plug, or after the air cleaner malfunctions, has been dropped or damaged in any manner. Discard the air cleaner or return to HoMedics Consumer Relations for examination, electrical or mechanical adjustment, or repair.
- This air cleaner is not intended for use in bathroom, laundry areas and similar moist indoor locations. Never locate air cleaner where it may fall into a bathtub or other water container.
- Do not run cord under carpeting. Do not cover cord with throw rugs, runners or similar coverings. Do not route cord under furniture or appliances. Arrange cord away from traffic areas where it can be tripped over.
- To disconnect the air cleaner, first turn controls to the OFF position, then remove plug from outlet.
- Do not tilt or move the air cleaner while it is in operation. Shut off and remove plug from outlet before moving.
- Do not insert or allow foreign objects to enter any ventilation or exhaust opening as this may cause an electric shock or fire, or damage the air cleaner.
- To prevent a possible fire, do not block air intakes or exhaust in any manner. Do not use on soft surface, like a bed, where openings may become blocked.
- Use this air cleaner only for its intended use as described in this manual. Any other use not recommended by the manufacturer may cause fire, electric shock, or injury to persons.
- Always plug the air cleaner directly into a wall outlet/receptacle. Never use with an extension cord.

SAVE THESE IMPORTANT INSTRUCTIONS FOR EASY REFERENCE

Technical Specifications

Input voltage	220-240 V
Rated Frequency	50 HZ
Weight	5.10kg
Noise Level	<60 dB
Unit Height	47cm

Plug (MODEL AR-20-GB ONLY)

If the plug on this appliance is damaged, it can be replaced with a BS 1363 plug, fitted with a 3A BS 1362 fuse. Only use a 3 amp fuse with this appliance. Care must be taken when changing the plug. If in doubt, contact a qualified electrician.

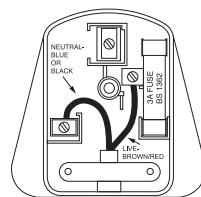

WEEE explanation



This marking indicates that this product should not be disposed with other household wastes throughout the EU. To prevent possible harm to the environment or human health from uncontrolled waste disposal, recycle it responsibly to promote the sustainable reuse of material resources. To return your used device, please use the return and collection systems or contact the retailer where the product was purchased. They can take this product for environmental safe recycling.

Battery Directive



This symbol indicates that batteries must not be disposed of in the domestic waste as they contain substances which can be damaging to the environment and health. Please dispose of batteries in designated collection points.

PRODUCT FEATURES:

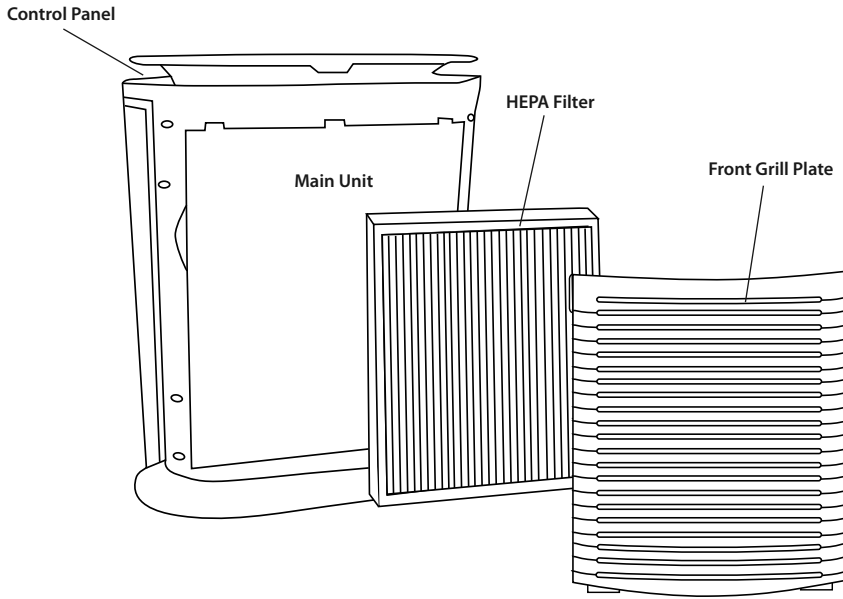

Control Panel

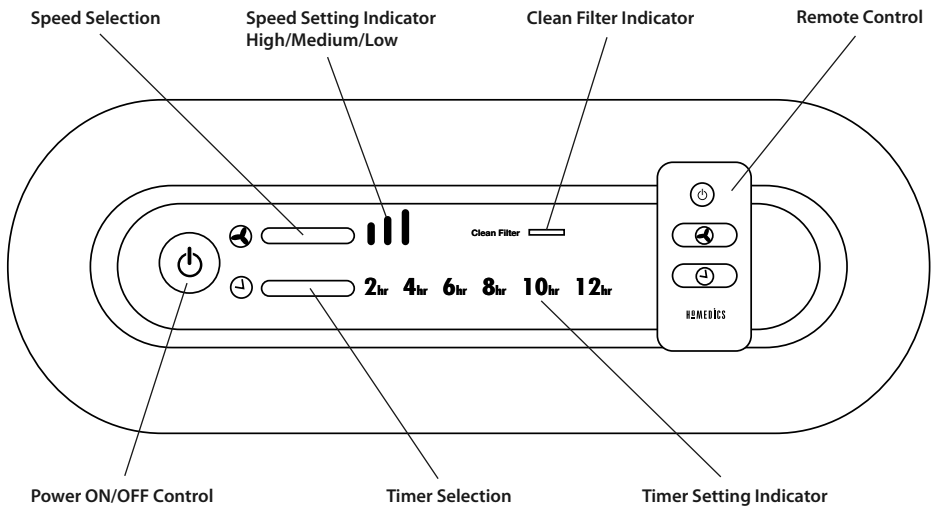

OPERATING INSTRUCTIONS

Turning the Unit On

Take the air cleaner out of the box and remove the clear protective plastic bag.

Place the air cleaner on a firm level surface.

Before turning the air cleaner ON, you need to confirm that the filter is firmly in place and did not become loose during shipping.

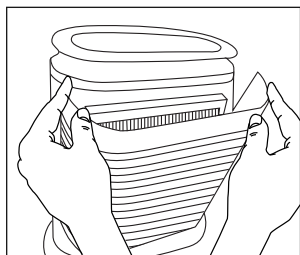

Fig.1

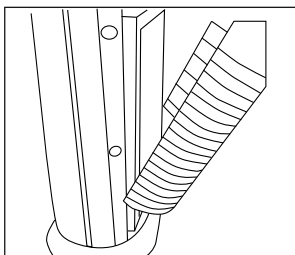

Fig.2

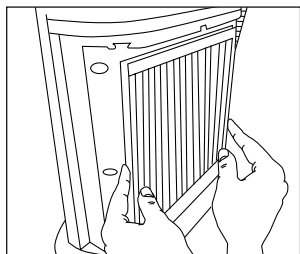

Fig.3

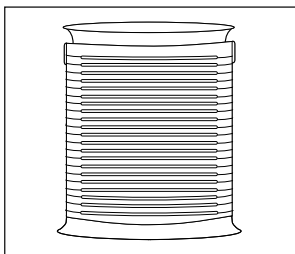







Fig.4

1. To check filter, open the front grill by gently pulling on the tabs on either side of the top of the grill plate (Fig 1).
2. Open the plate outward until the tabs at the bottom of the grill plate easily slide away from the unit (Fig 2).
3. The HEPA filter will be resting inside the unit. Make sure that the filter is firmly seated inside of the unit (Fig 3).
4. Place the tabs at the bottom of the grill plate into the base of the unit. Gently push the grill plate back into place until you hear a click sound indicating that the grill is firmly latched. Connect the power cord into a standard AC outlet (Fig 4).



1. On/Off and Speed Settings

To turn the air cleaner on, press the ON/OFF  button on the control panel. When the air cleaner is on, the LED light in the ON/OFF button on the control panel will be lit and the air cleaner will start to operate on LOW speed.

Once the air cleaner is ON, press the SPEED  button to select speed settings. The speeds will cycle as follows LOW  -> MEDIUM  -> HIGH  each time the SPEED button is pressed, and the corresponding symbol on the LED control panel will light. The cycle will repeat starting back at LOW.

To turn the air cleaner OFF, simply press the ON/OFF  button on the control panel.

2. Timer

There are six possible timer settings: 2 (two) hours, 4 (four) hours, 6 (six) hours, 8 (eight) hours, 10 (ten) hours and 12 (twelve) hours. To activate the timer and select a time setting, press TIMER  on the control panel. Each time the TIMER  function is pressed, it will switch between settings in a repeating cycle as follows: 2 hours, 4 hours, 6 hours, 8 hours, 10 hours, 12 hours, OFF. Press again and the cycle begins again. The selection will light up on the LED control panel matching the time period. When the timer is OFF, no selections will be lit.

USING THE REMOTE CONTROL

Battery Installation

One CR2032 3V battery is included with the remote control. To activate the remote control functions, pull out the plastic pull tab protruding from the remote control housing. To change the battery, remove the battery door at the back of the remote by squeezing the tab and pulling the door away from the back of the remote. Please insert the battery into the remote with the positive side up as shown on the drawer.

NOTE: Always keep the battery and remote control out of the reach of children.

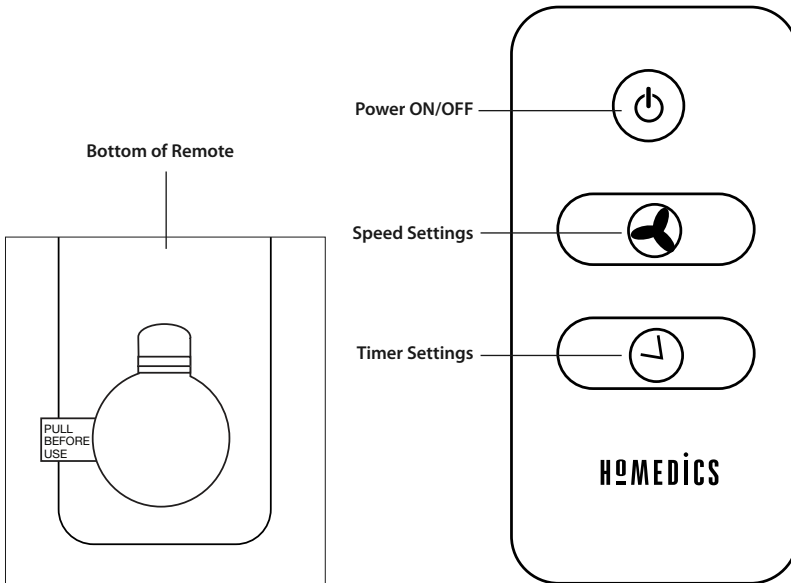

CLEANING AND MAINTENANCE

We recommend that the air cleaner be cleaned at least once a month and before storage.

Turn the air cleaner OFF at the main switch and unplug it from the outlet.

Use a dry cloth to clean the external surfaces of the air cleaner.

The grill plate may be cleaned with a damp cloth or the brush attachment of your vacuum cleaner.

DO NOT USE WATER, WAX, POLISH OR ANY CHEMICAL SOLUTION

Clean Filter Indicator

The air cleaner is equipped with a CLEAN FILTER indicator to let the user know when it is time to clean the HEPA filter, about every 2,160 hours of use. When the HEPA filter is ready to be cleaned, the LED CLEAN FILTER indicator will light up on the control panel.

Once the HEPA filter has been cleaned, press and hold the CLEAN FILTER indicator to reset until it beeps.

Cleaning the HEPA Filter

Make sure that the air cleaner is turned OFF and unplugged from the outlet before cleaning.

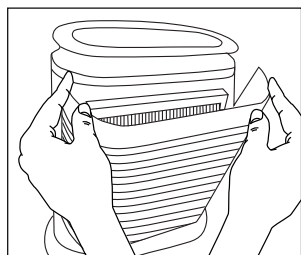

Fig.5

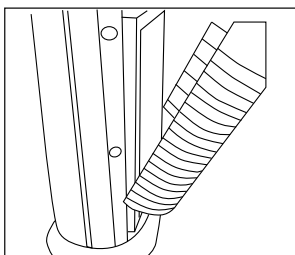

Fig.6

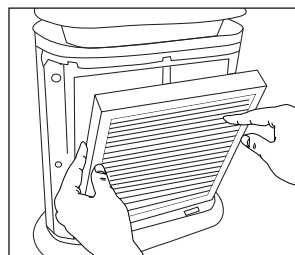

Fig.7

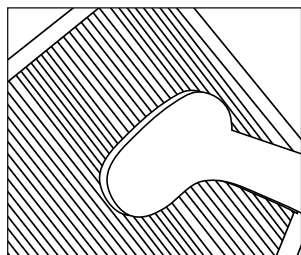

Fig.8

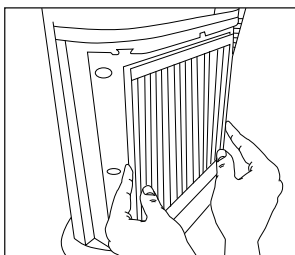

Fig.9

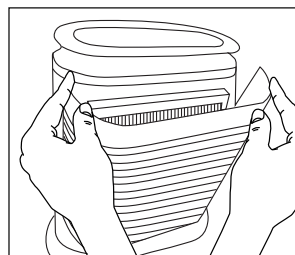

Fig.10

1. Open the front grill by gently pulling on the tabs on either side of the top of the grill plate (Fig. 5).
2. Open the plate outward until the tabs at the bottom of the grill plate easily slide away from the unit (Fig. 6).
3. Remove the HEPA filter from the main unit (Fig. 7).
4. Use the brush attachment with your vacuum cleaner. Run the attachment along both sides of the HEPA filter, cleaning thoroughly between the accordion folds of the filter (Fig. 8).
5. Place the clean HEPA filter back in the main unit, making sure that it is firmly seated inside the unit (Fig. 9).
6. Place the tabs at the bottom of the grill plate into the base of the unit. Gently push the grill plate back into place until you hear a click sound indicating that the grill is firmly latched (Fig.10).

DO NOT USE WATER OR ANY HOUSEHOLD CLEANERS OR DETERGENTS TO CLEAN THE HEPA FILTER.

It is recommended that you replace the HEPA filter every 18 months to maintain the optimal performance of your air cleaner. To purchase the HEPA replacement filter, go back to your retailer (where you purchased your air cleaner) or visit www.homedics.com

TROUBLESHOOTING

PROBLEM	POSSIBLE CAUSE	SOLUTION
Unit will not operate	<ul style="list-style-type: none">• Unit is not plugged in• No power at unit	<ul style="list-style-type: none">• Plug unit in• Press the POWER button to turn the power on• Check circuits, fuses, try a different outlet
Reduced airflow or poor filtering	<ul style="list-style-type: none">• The front grill may be blocked• HEPA filter may be clogged	<ul style="list-style-type: none">• Check to make sure nothing is blocking the front grill and air outlet• Check and clean filter• Replace the filter
Excessive Noise	<ul style="list-style-type: none">• The unit is not level	<ul style="list-style-type: none">• Place the unit on a flat, even surface





HOMEDICS®

CE

IB-AR-20-GB-1212-01