

HOMEDICS[®]

LEADERS IN HEALTH & WELLBEING



Register your product today at
www.homedicsgroup.com/register



TOTALCLEAN AIRPURIFIER

.....
instruction manual

AP-25A-GB

3 YEAR Guarantee

READ ALL INSTRUCTIONS BEFORE USE.
SAVE THESE INSTRUCTIONS FOR FUTURE
REFERENCE.

IMPORTANT SAFEGUARDS:

WHEN USING ELECTRICAL PRODUCTS,
ESPECIALLY WHEN CHILDREN ARE PRESENT,
BASIC SAFETY PRECAUTIONS SHOULD
ALWAYS BE FOLLOWED, INCLUDING THE
FOLLOWING:

- ALWAYS unplug the appliance from the electrical outlet immediately after using and before cleaning. To disconnect, turn all controls to the 'OFF' position, then remove plug from outlet.
- NEVER leave an appliance unattended when plugged in. Unplug from the mains outlet when not in use and before putting on or taking off parts or attachments.
- This appliance can be used by children aged from 8 years and above and persons with reduced physical, sensory or mental capabilities or lack of experience and knowledge if they have been given supervision or instruction concerning use of the appliance in a safe way and understand the hazards involved. Children shall not play with the appliance. Cleaning and user maintenance shall not be made by children without supervision.
- DO NOT reach for an appliance that has fallen in water or other liquids. Switch off at the mains and unplug it immediately. Keep dry – DO NOT operate in wet or moist conditions.
- NEVER insert pins or other metallic fasteners into the appliance.
- Use this appliance for the intended use as described in this booklet. DO NOT use attachments not recommended by HoMedics.
- NEVER operate the appliance if it has a damaged cord or plug, if it is not working properly, if it has been dropped or damaged, or dropped into water. Return it to the HoMedics Service Centre for examination and repair.
- Keep cord away from heated surfaces.
- Excessive use could lead to the product's excessive heating and shorter life. Should this occur, discontinue use and allow the unit to cool before operating.
- NEVER drop or insert any object into any opening.
- DO NOT operate where aerosol (spray) products are being used or where oxygen is being administered.
- DO NOT operate under a blanket or pillow. Excessive heating can occur and cause fire, electrocution or injury to persons.
- DO NOT carry this appliance by the cord or use cord as a handle.
- DO NOT use outdoors.
- This product requires a 220-240 V AC power.
- DO NOT attempt to repair the appliance. There are no user serviceable parts. For service, send to a HoMedics Service Centre. All servicing of this appliance must be performed by authorised HoMedics service personnel only.
- Never block the air openings of the appliance. Keep air openings free of lint, hair etc.
- Do not place or store appliance where it can fall or be pulled into a bath or sink. Do not place in or drop into water or other liquid.
- Failure to follow the above may result in the risk of fire or injury.

SAFETY CAUTIONS:

PLEASE READ THIS SECTION CAREFULLY BEFORE USING THE APPLIANCE.

- **If you have any concerns regarding your health, consult a doctor before using this appliance.**
- This appliance should NEVER be used by any individual suffering from any physical ailment that would limit the user's capacity to operate the controls.
- If the product feels excessively hot, switch off at mains and contact the HoMedics Service Centre.
- This appliance is designed for personal, non-professional use only.
- Do not run cord under carpeting. Do not cover cord with throw rugs, runners or similar coverings. Do not route cord under furniture or appliances. Arrange cord away from traffic areas where it can be tripped over.
- Do not tilt or move the personal space cooler while it is in operation. Shut off and remove plug from outlet before moving.
- Always plug the personal space cooler directly into a wall outlet/receptacle. Never use with an extension cord.

MAINTENANCE:

Cleaning

Unplug from the mains and use a soft damp cloth to clean the fabric if required. Never saturate the mat or use harsh chemical cleaners. No other maintenance is required.

Storage

Place the appliance in its box or in a safe, dry, cool place. Avoid contact with sharp edges or pointed objects which might cut or puncture the fabric surface. To avoid breakage, DO NOT wrap the power cord around the appliance. DO NOT hang the unit by the cord.

WEEE explanation

 This marking indicates that this product should not be disposed with other household wastes throughout the EU. To prevent possible harm to the environment or human health from uncontrolled waste disposal, recycle it responsibly to promote the sustainable reuse of material resources. To return your used device, please use the return and collection systems or contact the retailer where the product was purchased. They can take this product for environmental safe recycling.

PRODUCT FEATURES:

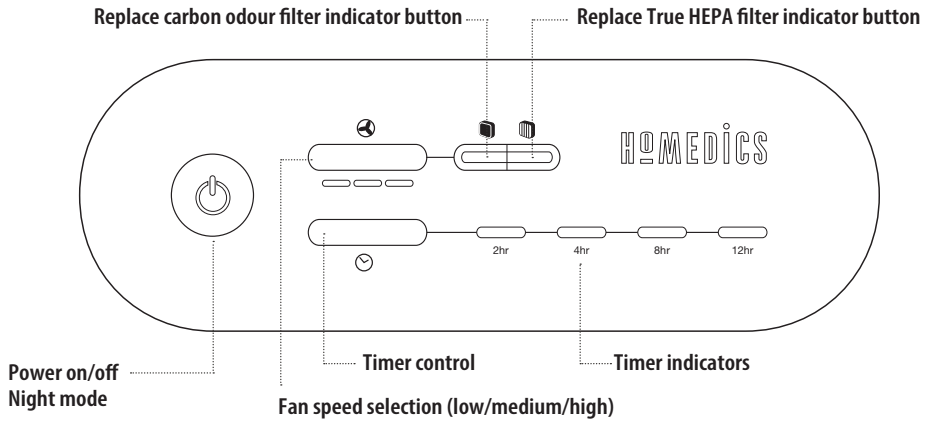
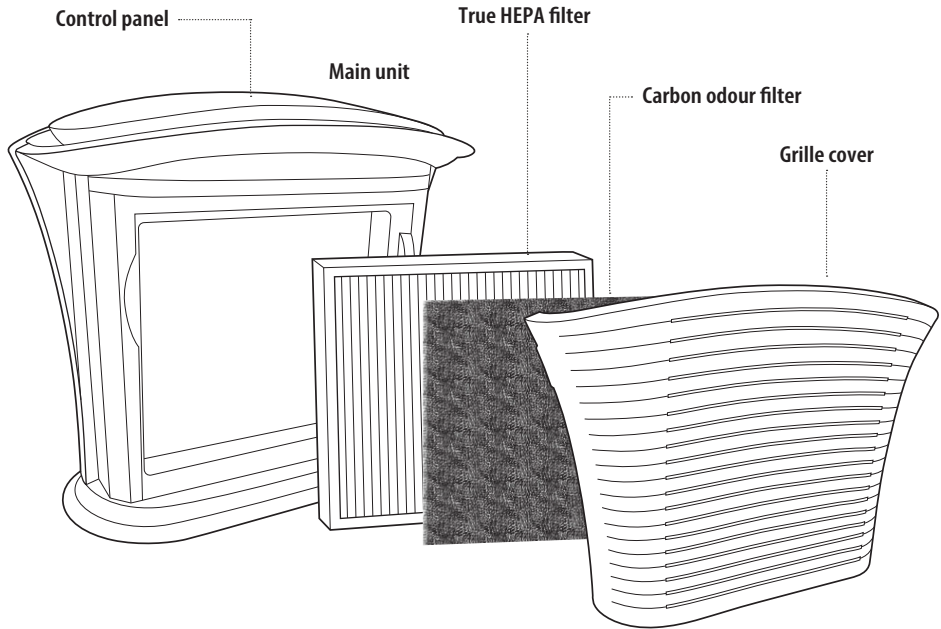

True HEPA filtration

Removes up to 99.97% of airborne particles as small as 0.3 microns such as allergens, pollen, dust, germs, pet dander, odor, mold spores and smoke.

Carbon odour filter

Reduces household odours and captures large particles.

3 Speeds

Low, medium and high speeds.

Night Mode

Turns off the display light while air purifier continues to operate.

Built-in timer

Programmable, choose from 2, 4, 8 or 12 hours

Replace Filter Indicators

Illuminates when it is time to replace the True HEPA or carbon odour Filter.

Suggested room size

17.1 M² / 184 FT². Portable air purifiers will be more effective in rooms where all the doors and windows are closed.

Air changes per hour

This air purifier will purify the air in a 17.1 M² / 184 FT² room (assuming a 2.43 M / 8 FT ceiling) 4.8 times per hour on high speed in a closed room.

HOW TO USE:

Before turning the unit on

- Take the air purifier out of the box and remove the clear protective plastic bag.
- Place the air purifier on a firm level surface.
- Locate the carbon odour filter inside the box and remove the protective plastic bag.
- Install the carbon odour filter and make sure the True HEPA filter is firmly in place.

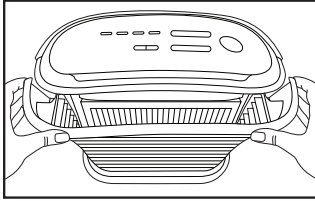

1. Open the back grille by pulling on the tabs on either side of the top of the grille cover.

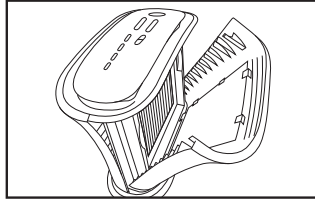

2. Open the cover outward until the tabs at the bottom of the grille cover easily slide away from the unit.

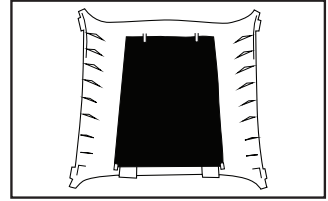

3. The top of the carbon odour filter has 2 slots for installation. Hang the carbon odour filter on the top tabs on the inside of the grille cover and secure under the bottom tabs.

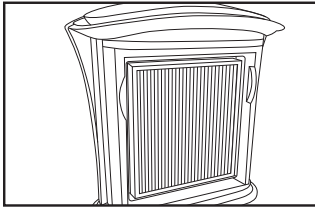



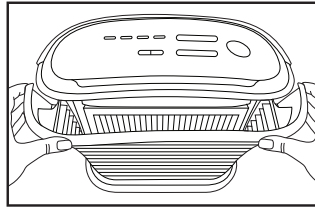

4. The True HEPA filter will be resting inside the unit. Make sure the filter is firmly seated inside the unit with the air flow arrows pointing toward the inside of the air purifier.





5. Place the tabs at the bottom of the grille cover into the base of the unit. Gently push the grille cover back into place until you hear a click sound indicating that the grille cover is firmly latched. Plug the power cord into a standard outlet.

On/off and fan speed settings

- To turn the air purifier on, press the ON/OFF  button. When the air purifier is on, the ON/OFF button will illuminate and the air purifier will start to operate.
- To activate NIGHT MODE and turn the air purifier display lights off, press the ON/OFF  button a second time
- **NOTE:** Night mode can only be activated when the air purifier is powered on.
- To turn the air purifier display lights off, press the ON/OFF  button a second time.
- To turn the air purifier off, Press the ON/OFF  button a third time.
- This air purifier has 3 fan speed settings: LOW (1), MEDIUM (2), and HIGH (3). The higher the fan speed setting, the faster the air will be purified. To select or change fan speed, slide the FAN SPEED  Control until desired speed is reached.

Timer

Select timed operation of your air purifier with the TIMER  Control. Timed operation of up to 12 hours can be selected. The air purifier will turn off automatically after the selected timer interval has elapsed. Use the timer setting whenever you wish to maintain air quality over a given time period (up to 12 hours), but do not wish to leave your air purifier running continuously. To select timed operation, press the TIMER  Control until desired timer setting is reached. Timer interval selected is indicated by the illuminated time interval to the right of the timer control. To deselect timed operation, cycle through all timer settings until no timer interval is illuminated.

REPLACING THE FILTERS

Replace carbon odour filter indicator button

The Replace Carbon Odour Filter Indicator illuminates when it is time to replace the Carbon Odor Filter based on the air purifier's hours of use.

Replace True HEPA Filter Indicator Button

The Replace True HEPA Filter Indicator illuminates when it is time to replace the True HEPA Filter based on the air purifier's hours of use.

Filter Replacement

It is recommended to check the filters on occasion if used to remove stronger odors or under heavy pollen conditions.

Replacing the carbon Odor Filter

For optimal performance, replace every 3-months under normal usage conditions. Once the Carbon Odour Filter has been replaced, press and hold the Replace Carbon Odour Filter Button for 3-seconds to reset the indicator.

To purchase HoMedics replacement carbon odour filters (model AP-25CRF-EU), visit www.homedics.co.uk

Replacing the True HEPA Filter

For optimal performance, replace every 12-months under normal usage conditions. Once the True HEPA Filter has been replaced, press and hold the Replace True HEPA Filter Button for 3-seconds to reset the indicator.

To purchase HoMedics replacement True HEPA Filters (model PP-AP25FL), visit www.homedics.co.uk

CLEANING AND CARE

CAUTION: Before cleaning the unit, turn power off and unplug the Power Adapter from the wall and the unit.

For best performance, we recommend:

- NEVER use water or any household cleaners or detergents to clean the True HEPA filter or carbon odour filter.
- Clean off the outside of the unit with a dry cloth once a month.
- NEVER use water, wax, polish, or any chemical solution to clean the outside of the unit.
- Clean off the grille cover using a damp cloth or the brush attachment of your vacuum once a month.
- Replace the carbon odour filter every 3 months under normal usage conditions.
- Replace the True HEPA filter every 12 months under normal usage conditions.
- Always use genuine HoMedics replacement filters for optimal performance.

TROUBLESHOOTING

PROBLEM	POSSIBLE CAUSE	SOLUTION
Unit will not operate	<ul style="list-style-type: none">• Unit is not plugged in• No power to unit	<ul style="list-style-type: none">• Plug unit in• Press the power on/off button to turn the unit on• Check circuits and fuses or try a different outlet
Reduced airflow or poor filtering	<ul style="list-style-type: none">• The back grille may be blocked• True HEPA filter may be clogged• Carbon odour filter may be clogged	<ul style="list-style-type: none">• Check to make sure nothing is blocking the back grille and air outlet• Replace the filters
Excessive noise	<ul style="list-style-type: none">• The unit is not level	<ul style="list-style-type: none">• Place the unit on a flat, level surface
Replace filter light remains lit after filter replacement	<ul style="list-style-type: none">• The appropriate replace filter indicator needs to be reset	<ul style="list-style-type: none">• Press and hold the appropriate replace filter button for 3 seconds
The air purifier seems to be producing odours	<ul style="list-style-type: none">• The filters need replacing	<ul style="list-style-type: none">• Replace the filters as needed



LEADERS IN HEALTH & WELLBEING

THREE YEAR GUARANTEE

HoMedics Inc. guarantees this product from defect in material and workmanship for a period of 3 years from the date of purchase, except as noted below. This HoMedics product guarantee does not cover damage caused by misuse or abuse; accident; the attachment of any unauthorised accessory; alteration to the product; or any other conditions whatsoever that are beyond the control of HoMedics. This guarantee is effective only if the product is purchased and operated in the UK / EU. A product that requires modification or adaptation to enable it to operate in any country other than the country for which it was designed, manufactured, approved and / or authorised, or repair of products damaged by these modifications is not covered under this guarantee. HoMedics shall not be responsible for any type of incidental, consequential or special damages.

To obtain guarantee service on your product, return the product post-paid to your local service centre along with your dated sales receipt (as proof of purchase). Please refer to 'HoMedics Service Centre' information leaflet for details of your local service centre. Upon receipt, HoMedics will repair or replace, as appropriate, your product and return it to you, post-paid. Guarantee is solely through HoMedics Service Centre. Service of this product by anyone other than the HoMedics Service Centre voids the guarantee.

This guarantee does not affect your statutory rights.

HoMedics Service Centre

HoMedics Group Ltd,
HoMedics House,
Somerhill Business Park,
Five Oak Green Road,
Tonbridge,
Kent TN11 0GP, UK.
T +44 (0) 1732 360783
e support@homedics.co.uk
www.homedics.co.uk



IB-AP25AGB-0917-01